

IM-RM

Industrial metering

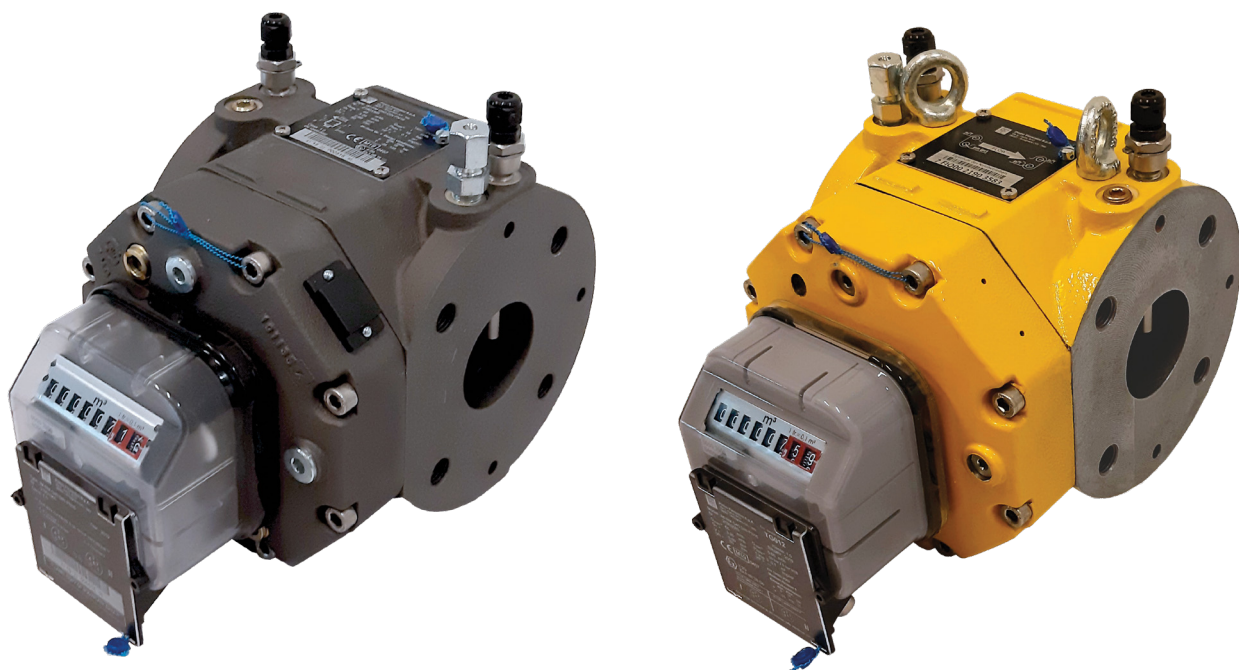

TECHNICAL BROCHURE

Pietro Fiorentini S.p.A.

Via E.Fermi, 8/10 | 36057 Arcugnano, Italy | +39 0444 968 511
sales@fiorentini.com

The data are not binding. We reserve the right
to make changes without prior notice.

imrm_technicalbrochure_ENG_revA

www.fiorentini.com

Who we are

We are a global organization specialized in designing and manufacturing technologically advanced solutions for natural gas treatment, transmission and distribution systems.

We are the ideal partner for operators in the Oil & Gas sector, with a business offer that goes across the whole natural gas chain.

We are in constant evolution to meet our customers' highest expectations in terms of quality and reliability.

Our aim is to be a step ahead of the competition, with customized technologies and an after-sale service program undertaken with the highest grade of professionalism.



Pietro Fiorentini advantages



Localised technical support



Experience since 1940



We operate in over 100 countries

Area of Application

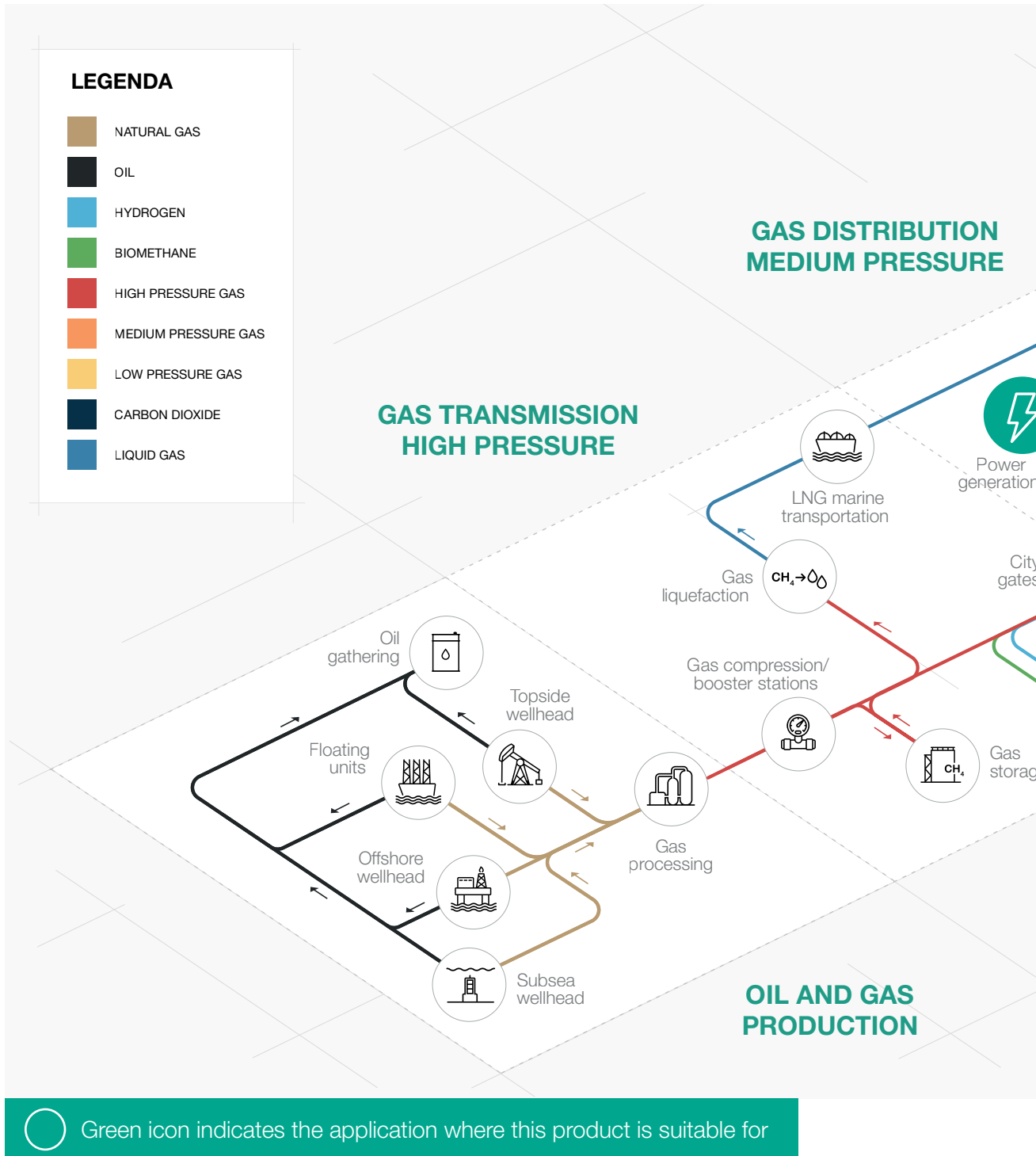

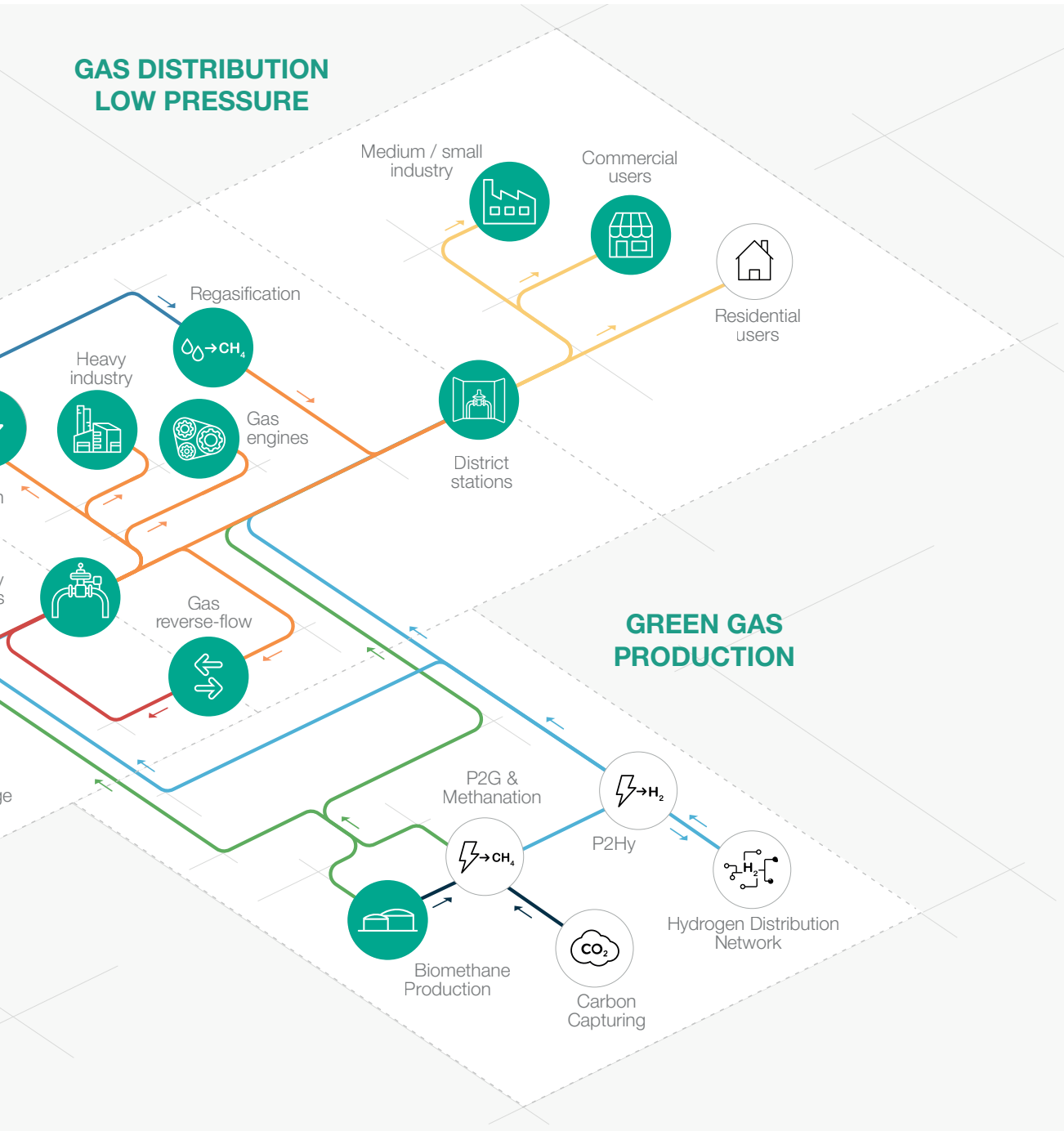

Figure 1 Area of application map



Introduction

Natural gas Companies worldwide use Pietro Fiorentini rotary meters in commercial and industrial natural gas measurement applications. Our rotary meters are also used in both high flow residential applications and low volume transmission applications. Pietro Fiorentini rotary meters are used at the well head gathering line, compressor stations, gas distribution systems, and end users such as chemical and processing plants.

Meters of standard construction are used in the measurement of a variety of filtered and dry non corrosive gases, including specialty gases. Pietro Fiorentini rotary meters are approved for custody transfer applications and used by natural gas transmission and gas distribution companies. Some sizes of meters are available in the HTR version (High Temperature Resistance) according to EN12480 Annex C

Rotary Meters measurement principle

Pietro Fiorentini rotary meters are designed to measure the volume of gases and gas mixtures with a high degree of accuracy. The rotary type positive displacement operating principle assures permanent, non adjustable accuracy by using two precision machined dual lobed impellers encased within a rigid measuring chamber. Unlike other meter types, measurement accuracy is not affected by changes in gas specific gravity, pressure, or fluctuating flow. Pietro Fiorentini rotary meters may be used from atmospheric pressure to 20 bar with highly accurate measurement over a wide operating range.

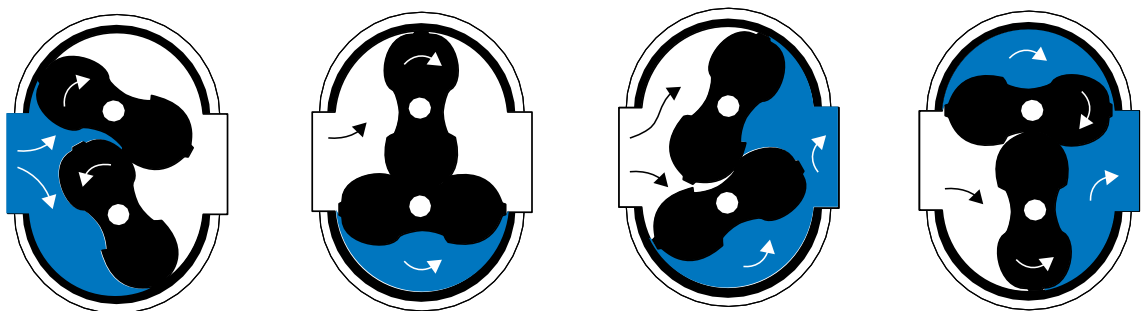

As shown in the picture, two contrarotating impellers of two lobe shaped like an 8, are encased within a rigid measuring chamber, with the inlet and outlet connections on opposite sides. Precision machined timing gears keep the impellers in correct relative position.

Optimal operating clearances between the impellers, cylinder and headplates provide a continuous, non contacting seal. Two precision machined dual lobed impellers encased within a rigid measuring chamber

Features

Rotors

The precision machined high performance rotors are held in place with four main shaft bearings placed outside of the timing gears. This bearing placement strengthens the connection between the rotors and the timing gears.

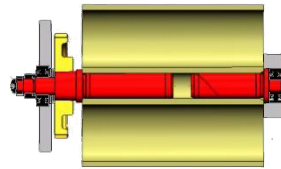
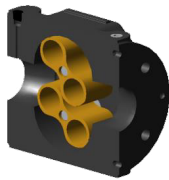

The sophisticated square profile impellers improve not only the accuracy, but also the rangeability of the meter by minimizing leakage between rotors and the body. This design also reduces the deflection of the rotor's main shafts at high flow rate and elevated pressure where dynamic loading is most prevalent. This feature makes the meter less vulnerable to damage during start up and operation.

Rugged Design

The Pietro Fiorentini rotary meter's rugged design is less sensitive to stress from misaligned pipe or flanged connections. Our compact meter body, thick flange connections, and stainless steel bearing support rings facilitate easy installation, and robust performance in the most demanding installations. The square rotors with rigid main shafts are also less susceptible to damage from rapid pressurization of the meter.

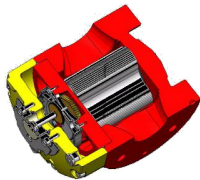

Repair technicians can replace all major parts without special tools. This innovative Pietro Fiorentini measurement cartridge simplifies most maintenance and repair activities. Technicians can remove the complete measurement mechanism (rotors, timing gears, and bearings) from the meter body in one piece. Whether you just clean the cartridge and re install it, or replace the cartridge, major repairs are fast and easy.



Multifunctional Index

The Pietro Fiorentini rotary meters utilize a magnetically coupled index.

A “drive” magnet couples to the “follower” magnet of the index, which in turn drives the odometer on the meter index.



Pietro Fiorentini index uses an 8 digit odometer and provides direct readings in cubic meters. The index has IP67 degree of protection. The index can be removed or installed with just “one twist and a click”.

The magnetic coupling allows for adjustable orientation of 355° or exchange without decommissioning the meter.

A single index is adaptable to all rotary meter sizes due to the gear reduction internal to the meter body.

The gear reduction is used to turn the drive magnet at an output ratio common to all Pietro Fiorentini rotary meters.

By using a common index, the design enables standardization, reduces inventory and maximizes modular flexibility.

The Pietro Fiorentini index also contains a pocket that can hold different types of Low Frequency (LF) pulse devices, such as reed switches, or fraud detection/tamper indication devices.

For applications requiring serial communication, the Pietro Fiorentini index is available with an encoder. The encoder uses three optical sensors to detect light passing through a specially designed slotted disc rotating within the index. The light detected passing through the disc is converted to a numeric value using Gray Code.

The system offers high resolution and allows for instant flow calculation.

HTR Version

Some size Pietro Fiorentini rotary meter are also available in the HTR version (High Temperature Resistance).

The HTR version is compliant with EN12480 Annex C/DVGW Test Report 17 134 4703 082

Body material	Cast Iron EN-GJS-400-15 or EN-GJS-400-18LT
Flange connection	PN16 Flat-face
Maximum Operating Pressure	16 bar / 5 bar HTR
Surface treatment	Painted - Yellow RAL1004
Design Temperature range	-25 °C to +55 °C (-13°F to 131°F)
Operating Temperature range	-25 °C to +55 °C (-13°F to 131°F)

Twin Versions

The twin impeller design reduces downstream pulsations and noise. The eight-shaped lobe impeller rotary meter design inherently creates pulsations as gas flows through the measurement chamber. This is a common and typical phenomenon with rotary meters.

Resonance may affect the linearity of the calibration curve. The effect of such pulsations increases with pressure and the resultant resonance may affect components such as pressure regulators within the metering station.

Harmonics, or the shift in frequency created by pulsations, can limit the achievable Qmax as the pressure in the measuring chamber varies.

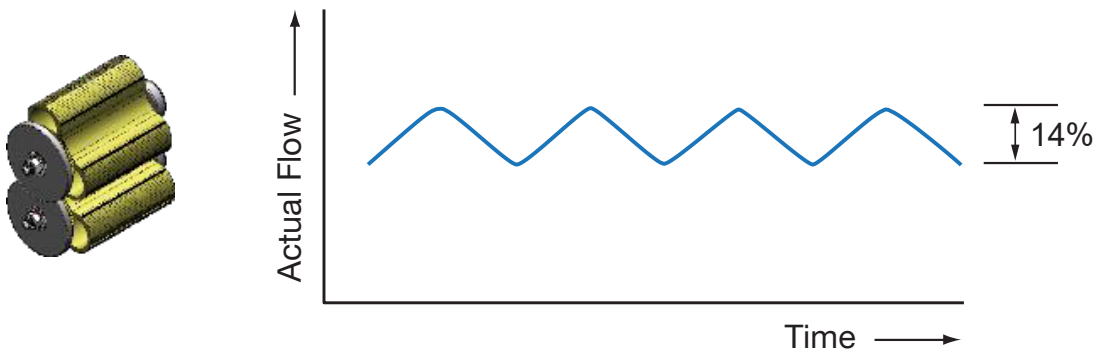



Harmonics is simply a column of air being resonated at its fundamental or lowest frequency. The small pulsation produced by the rotary meter occurs as the flow media quickly changes pressure as the measuring element (impellers) rotate.

The amplitude of the pulsation from the measurement cavity is directly proportional to the pressure drop across the meter and the speed of the rotating device. This resonant frequency of the gas flow tend to show up as a higher than expected nominal value on the performance curve.

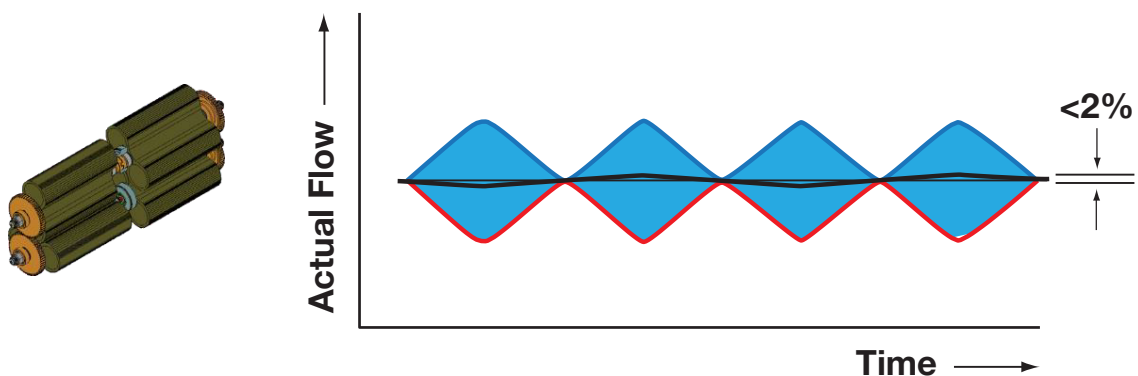

The Twin impeller principle, offered in the larger rotary meter sizes, divides the flow into two measuring chambers.

The phase of each pair of impellers is shifted 45 degrees (180 degrees in terms of the sine wave) so that the pulsations are opposing and negligible, or eliminated.

Pietro Fiorentini Twin rotary meters provide significantly improved accuracy over conventional rangeability make them ideal choices for reference or master meter applications. Reduced pulsations also significantly reduce ambient noise, making Twin rotary meters ideal for sound sensitive applications



The Twin version may have an internal by pass as an additional functionality, to guarantee gas supply in case of an emergency when the rotors are blocked. The by pass is automatically activated by exceeding a pressure drop value set in the factory. This desired pressure value must be communicated to us when ordering. The by pass device gives a guarantee for the end user that gas is still available also in case the meter is damaged.

This device cannot be activated by the user, but only by exceeding the set pressure drop.

The by pass device can be reset only by removing the instrument from the pipe and only after breaking the metrological seals.



Figure 2 By pass closed



Figure 3 By pass open



IM-RM competitive advantages



High rangeability



High performance rotor profile



Superior strength



Low pressure drop



Simplified maintenance and repair



Multi-functional Index



Compact size and lower weight



Decreased susceptibility to damage from pressure shocks



Biomethane compatible and
25% Hydrogen blending compatible.
Higher blending available on request**

(**) for aluminium body

Features

Features	Values
Flow rates*	from 0.5 m ³ /h to 1000 m ³ /h from 17.6 cfm to 35314 cfm
Design pressure*	up to 2.5 MPa up to 25 barg
Ambient temperature*	from -25 °C to +55 °C from -13 °F to 131 °F
Gas temperature range*	from -25 °C to +55 °C from -13 °F to 131 °F
Accuracy	$Q_{min} \leq Q < Q_t \pm 2\%$ & $Q_t \leq Q \leq Q_{max} \pm 1\%$ (Q_t according to EN12480)
Rangeability	up to 1:250
Repeatability	better than 0.1%
Index Protection	IP 67
Applicable metrology standards	MID 2014/32/EU
Index & pulse out	<ul style="list-style-type: none"> • 8 digits • 2x low frequency pulse out (NO reed contact) • 1x anti fraude out (NC reed contact)
Hazardous area certification	ATEX II 2 G Ex h IIB T6 Gb
Accessories	<ul style="list-style-type: none"> • optical encoder index • high frequency sensors • by-pass valve on Twin versions
Nominal dimensions DN	from DN 40 to DN 150
Connections*	ANSI 150 according to ASME B16.5 or PN 16/25 according to EN 1092-1
<p>(*) REMARK: Different functional features and/or extended temperature ranges available on request. Stated temperature ranges are the maximum for which the equipment's full performance, including accuracy, are fulfilled. Standard product may have a narrower range.</p>	

Table 1 Features

Materials and Approvals

Part	Material
Body	hard anodized aluminium alloy or spheroidal graphite cast iron
Rotor	aluminium alloy
Shaft & Bearings	stainless steel
Index enclosure	UV resistant polycarbonate case suitable for outdoor installation

REMARK: The materials indicated above refer to the standard models. Different materials can be provided according to specific needs.

Table 2 Materials

Construction Standards and Approvals

IM-RM rotary meters is designed to meet EN 12480 requirements & OIML R137 1&2 :2012.



EN 12261



OIML R137
1&2 :2012

The product is certified according to European Directive 2014/68/EU (PED), 2014/32/EU (MID), 2014/34/EU (ATEX).



PED



MID



ATEX

Capacity table

Available sizes nominal operating conditions (metric units)										
Model	Qmax	Qmin	Range	DN	Cyclic volume	Flange-Flange Distance	Weight Alum. HTR	LF impulses	HTR version Availability	
	m ³ /h	m ³ /h	max	mm	dm ³	mm	Kg	Imp. / m ³	Yes No	
G10	16	0.5	1:30	40	0.18	121	3.5	10	X	
G16	25	0.5	1:50	40	0.18		3.5	10	X	
G25	40	0.5	1:80	40	0.26		4	10	X	
G16	25	0.5	1:50	40 50	0.69	171	10 / 23	10	V Only DN50	
G25	40	0.5	1:80	40 50	0.69		10 / 23	10	V Only DN50	
G40	65	0.5	1:130	40 50	0.69		10 / 23	10	V Only DN50	
G65	100	0.5	1:200	50	0.69		10 / 23	10	V	
G65	100	1	1:100	80	1.11		12 / 30	10	V	
G100	160	1	1:160	50	1.11		12 / 30	1	X	
G100	160	1	1:160	80	1.11		12 / 30	1	V	
G100 - Twin	160	1.6	1:100	80	1.73		20.5	1	X	
G160 - Twin	250	1.6	1:160	80	1.73		20.5	1	X	
G100	160	1.6	1:100	80	2.31		241	22.5 / 56	1	V
G160	250	1.6	1:160	80	2.31			22.5 / 56	1	V
G100	160	2.5	1:65	100	2.98	27.5 / 62		1	V	
G160	250	1.6	1:160	100	2.98	27.5 / 62		1	V	
G250	400	2.5	1:160	100	2.98	27.5 / 62		1	V	
G250 - Twin	400	4.0	1:100	100	3.88	45		1	X	
G400 - Twin	650	4.0	1:160	100	3.88	45		1	X	
G400 - Twin	650	4.0	1:160	150	3.88	45		1	X	
G400 - Twin	650	6.5	1:100	150	5.97	56		1	X	
G650 - Twin	1000	6.5	1:160	150	5.97	56		1	X	

Table 3 Capacity and rangeability table (metric units)

Available sizes nominal operating conditions (imperial units)									
Model	Qmax	Qmin	Range	DN	Cyclic volume	Flange-Flange Distance	Weight Alum. HTR	LF impulses	HTR version Availability
	cuft/h	cuft/h	max	inches	in ³	inches	lbs	Imp/cuft	Yes No
G10	565	18	1:30	G1"½ or 1"½ NPT	11.0	4.8"	7.7	10	X
G16	883	18	1:50	G1"½ or 1"½ NPT	11.0		7.7	10	X
G25	1413	18	1:80	G1"½ or 1"½ NPT	15.9		8.8	10	X
G16	883	18	1:50	1"½ 2"	42.1	6.7"	22 / 50.7	10	V Only DN50
G25	1413	18	1:80	1"½ 2"	42.1		22 / 50.7	10	V Only DN50
G40	2295	18	1:130	1"½ 2"	42.1		22 / 50.7	10	V Only DN50
G65	3531	18	1:200	2"	42.1		22 / 50.7	10	V
G65	3531	35	1:100	3"	67.7		26.5 / 66.1	10	V
G100	5650	35	1:160	2"	67.7		26.5 / 66.1	1	X
G100	5650	35	1:160	3"	67.7		26.5 / 66.1	1	V
G100 - Twin	5650	57	1:100	3"	105.6		45.2	1	X
G160 - Twin	8829	57	1:160	3"	105.6		45.2	1	X
G100	5650	57	1:100	3"	141.0		9.5"	49.6 / 123.5	1
G160	8829	57	1:160	3"	141.0	49.6 / 123.5		1	V
G100	5650	88	1:65	4"	181.9	60.6 / 136.7		1	V
G160	8829	57	1:160	4"	181.9	60.6 / 136.7		1	V
G250	14126	88	1:160	4"	181.9	60.6 / 136.7		1	V
G250 - Twin	14126	141	1:100	4"	236.8	99.2		1	X
G400 - Twin	22955	141	1:160	4"	236.8	99.2		1	X
G400 - Twin	22955	141	1:160	6"	236.8	99.2		1	X
G400 - Twin	22955	230	1:100	6"	364.3	123.5		1	X
G650 - Twin	35315	230	1:160	6"	364.3	123.5		1	X

Table 4 Capacity and rangeability table (imperial units)



Accessories

Optical encoder index

When serial communication is required, the index is equipped with an encoder, composed by three optical sensors and electronics.

The optical sensors detect light passing through a specially designed slotted disc rotating within the index and the electronics convert it into a numeric value using Gray Code. The system offers high resolution and allows instantaneous flow calculation.



Figure 4 Optical encoder index

High Frequency sensor

Rotary meters may be provided with a HF (High Frequency) sensor. The sensor is coupled with a magnetic wheel inside the gearbox.

It is designed and approved in accordance with ATEX. The generated output signal complies with EN 60947-5-6/NAMUR.

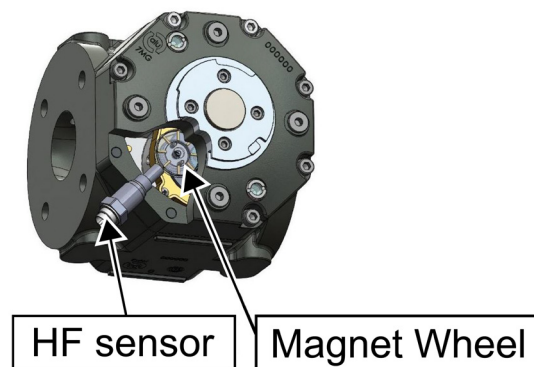

Figure 5 High Frequency sensor

Weights and Dimensions

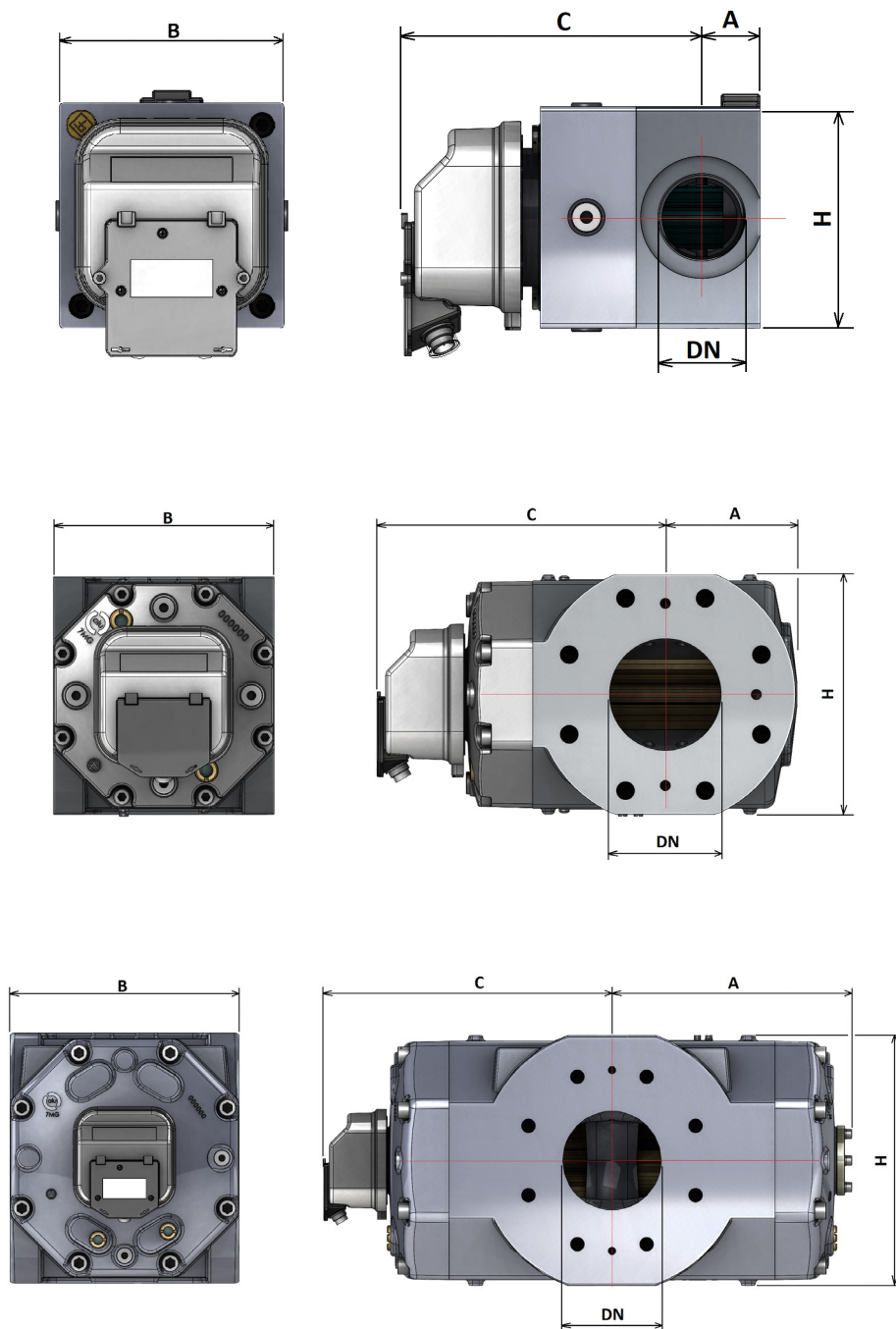

Figure 6 IM-RM dimensions



Dimensions (for other connections please contact your closest Pietro Fiorentini representative)										
Model	Dimension (DN)		A max		B ± 2 mm		C max		H max	
	[mm]	inches	[mm]	inches	[mm]	inches	[mm]	inches	[mm]	inches
G10	40	G1½ or 1½ NPT	35	1.4"	121	4.8"	175	6.9"	130	5.1"
G16	40	G1½ or 1½ NPT	35	1.4"	121	4.8"	175	6.9"	130	5.1"
G25	40	G1½ or 1½ NPT	50	2.0"	121	4.8"	175	6.9"	130	5.1"
G16	40 50	1½ 2"	85	3.3"	171	6.7"	190	7.5"	185	7.3"
G25	40 50	1½ 2"	85	3.3"	171	6.7"	190	7.5"	185	7.3"
G40	40 50	1½ 2"	85	3.3"	171	6.7"	190	7.5"	185	7.3"
G65	50	2"	85	3.3"	171	6.7"	190	7.5"	185	7.3"
G65	80	3"	100	3.9"	171	6.7"	220	8.7"	185	7.3"
G100	50	2"	100	3.9"	171	6.7"	220	8.7"	185	7.3"
G100	80	3"	100	3.9"	171	6.7"	220	8.7"	185	7.3"
G100 - Twin	80	3"	225	8.9"	171	6.7"	280	11.0"	185	7.3"
G160 - Twin	80	3"	225	8.9"	171	6.7"	280	11.0"	185	7.3"
G100	80	3"	100	3.9"	241	9.5"	240	9.4"	265	10.4"
G160	80	3"	100	3.9"	241	9.5"	240	9.4"	265	10.4"
G100	100	4"	130	5.1"	241	9.5"	255	10.0"	265	10.4"
G160	100	4"	130	5.1"	241	9.5"	255	10.0"	265	10.4"
G250	100	4"	130	5.1"	241	9.5"	255	10.0"	265	10.4"
G250 - Twin	100	4"	255	10.0"	241	9.5"	305	12.0"	265	10.4"
G400 - Twin	100	4"	255	10.0"	241	9.5"	305	12.0"	265	10.4"
G400 - Twin	150	6"	255	10.0"	241	9.5"	305	12.0"	265	10.4"
G400 - Twin	150	6"	325	12.8"	241	9.5"	375	14.8"	265	10.4"
G650 - Twin	150	6"	325	12.8"	241	9.5"	375	14.8"	265	10.4"

Table 5 Dimensions

Weights (for other connections please contact your closest Pietro Fiorentini representative)

Model	Dimension (DN)		Version					
			Aluminium		HTR ¹		Cast iron	
	[mm]	inches	Kg	lbs	Kg	lbs	Kg	lbs
G10	40	G1 ½ or 1 ½ NPT	3.5	8	-	-	-	-
G16	40	G1 ½ or 1 ½ NPT	3.5	8	-	-	-	-
G25	40	G1 ½ or 1 ½ NPT	4	9	-	-	-	-
G16	40 50	1 ½ 2"	10	22	23	51	23	51
G25	40 50	1 ½ 2"	10	22	23	51	23	51
G40	40 50	1 ½ 2"	10	22	23	51	23	51
G65	50	2"	10	22	23	51	23	51
G65	80	3"	12	26	-	-	30	66
G100	50	2"	12	26	-	-	30	66
G100	80	3"	12	26	30	66	30	66
G100 - Twin	80	3"	20.5	45	-	-	-	-
G160 - Twin	80	3"	20.5	45	-	-	-	-
G100	80	3"	22.5	50	56	123	56	123
G160	80	3"	22.5	50	56	123	56	123
G100	100	4"	27.5	61	62	137	62	137
G160	100	4"	27.5	61	62	137	62	137
G250	100	4"	27.5	61	62	137	62	137
G250 - Twin	100	4"	45	99	-	-	-	-
G400 - Twin	100	4"	45	99	-	-	-	-
G400 - Twin	150	6"	45	99	-	-	-	-
G400 - Twin	150	6"	45	99	-	-	-	-
G650 - Twin	150	6"	45	99	-	-	-	-

¹ HTR: High Temperature Resistant version compliant with Annex C of the EN12480 standard

Table 6 Weights



Pietro Fiorentini

TB0073ENG



The data are not binding. We reserve the right
to make changes without prior notice.

[imm_technicalbrochure_ENG_revA](#)

www.fiorentini.com